



Cordless  
**Faux**  
Wood  
**Blind**

owner's handbook





## INSTALLATION INSTRUCTIONS

### Step 1. Check Package Contents

Missing part? Call 800-264-1190

Mounting hardware kit includes the following:

Part	Quantity
a Mounting Brackets	2
b Center Support Brackets	1 (28 $\frac{1}{8}$ " to 40") 2 (40 $\frac{1}{8}$ " to 48") 3 (48 $\frac{1}{8}$ " to 72")
c 1 $\frac{1}{4}$ " Screws	2 per bracket 2 per center support
d Hold Down Brackets	2
e 7/8" Screws for Hold Down	4
f Valance Clips	2 (blinds up to 40" wide) 3 ( blinds 40 $\frac{1}{8}$ " to 48" wide) 4 (blinds 48 $\frac{1}{8}$ " to 72" wide)
g Valance Returns	2
h Valance/Return Connectors	2

### Step 2. Tools required

Screwdriver, tape measure, pencil, drill, drill bits, step ladder.

Note: use #6 plastic anchors (not included) for dry wall or plaster mounting.

Drill Bits: for screws, use a 3/32" drill bit - for wall anchors, use 1/4" drill bit.

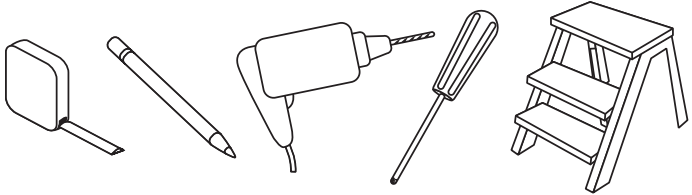

### Step 3. Bracket Location and Installation

Your blind may be installed either inside the window frame or outside the window frame. A mounting bracket should be placed at each end of the head rail as illustrated. Note that the screws can be attached to the side, back or top of the bracket based on your need or preference. For wider shades that require Center Supports, these should be spaced evenly between the two outside brackets. Always position the supports such that there is no interference with the tilter cords and lift cords (if there is only one center support it must be positioned off-center).

Mark bracket and screw hole locations with a pencil – pre-drill the screw holes using a 3/32" drill bit, and then attach the brackets using the 1 $\frac{1}{4}$ " screws.

**For Outside Mounts**, we recommend that you place a bracket on both ends of the head rail, use tape to hold the brackets in place if necessary (do the same for the center support(s) if applicable). Hold the blind level at the height desired and center it over the

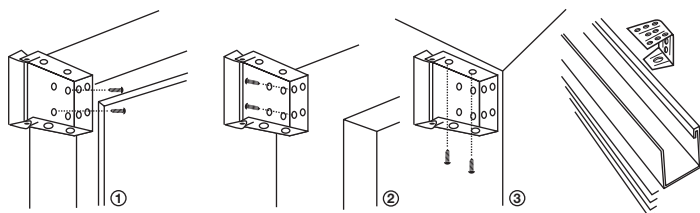

window opening — mark the exact location of each bracket with a pencil, and then attach the brackets as described above.

#### Step 4. Inserting the Head Rail

Slide the head rail onto the brackets, and then snap-close the hinged retainer caps of the end brackets.

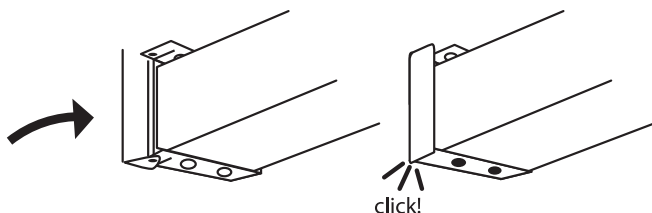

#### Step 5. Attach the Tilt Wand

Note: the ring that the Tilt Wand is attached to is recessed within the head rail when the blind is packaged — it should slide out when you mount the shade — if it does not, reach in with your fingers and pull the ring out. Hook the wand onto the ring and tilt away. See important operating instructions below.

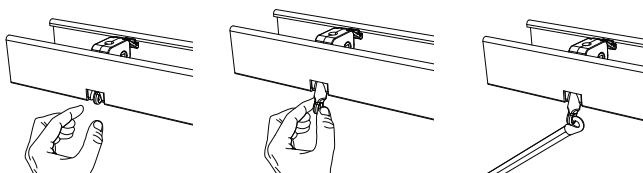

#### Step 6. Install Valance Clips and Valance

**For inside mounts** — attach the clips to the valance as shown — position them evenly across the valance — before attaching the valance to the head rail be sure that the clips will not interfere with the mechanisms inside the head rail — adjust the clips as necessary..

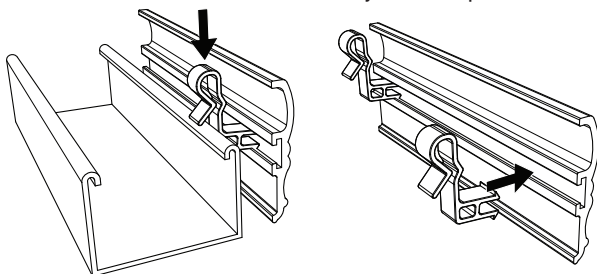

**For outside mounts** — attach the Valance Returns to the Valance as illustrated - slide a connector into the end of both returns, and then attach each return to the valance as shown — snug-up the corners

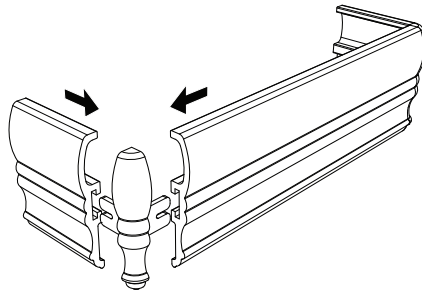

by hand. Attach the clips to the Valance as described above, and then slide the clips onto the head rail.

### Step 7. How to Operate

**IMPORTANT**  
**Operating & Care Instructions for Cordless Blinds**  
**READ CAREFULLY**

- Always rotate the slats to the “open” horizontal position before raising or lowering. This assures smooth operation and increases the life of the blind.
- To maintain optimal performance of the springs that make your cordless blind function, lift and lower your blind through its full range of motion – all the way up and all the way down - as frequently as possible
- Always raise and lower the blind SLOWLY(!) to assure that the slats stack neatly. To lower the shade: grip the bottom rail with both hands and slowly pull straight down. To raise the shade, put both hands under the bottom rail and push up slowly.

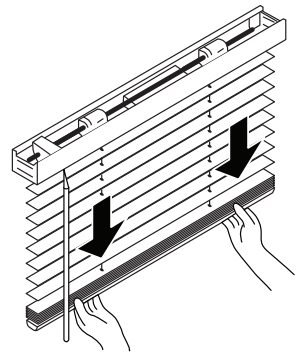
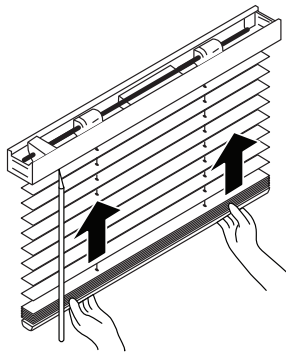

- **Always keep the bottom rail level.**
- If you have trouble lifting your cordless blind:  
 If the blind is left in one position for a long period of time, it might be necessary to lift and lower the shade several times to restore normal function.  
 If the blind has been fully raised for a long period of time, it might tend to spring-back (rebound) slightly from the desired length position. This can also be remedied by lifting and lowering the blind several times.

Cordless  
**Faux**  
 Wood  
 Blind

### **Step 8. Installing Hold Down Brackets**

Hold Down brackets should be used only if the blind is to be in a permanently lowered position.

With the blind fully lowered, make pencil marks at the outside ends of the bottom rail. The outside edge of each bracket should be lined up to the pencil marks and screwed into place using the 7/8" screws. Insert the pins protruding from the brackets into the holes on both ends of the bottom rail (see illustration)

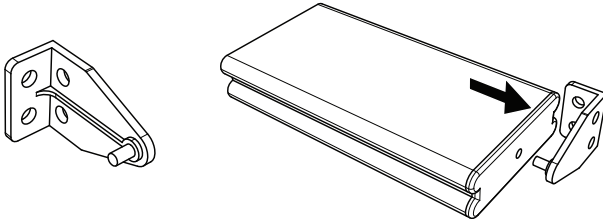

### **Cleaning your Blinds**

**Dusting:** use a soft cloth, feather duster, cylindrical dust brushes specifically designed for blinds or vacuum using the soft brush attachment.

**Washing:** use a cloth, sponge or soft brush and a mild detergent. Use warm or cold water, not hot water. Place toweling on the floor and/or window sill and wash the blind in sections. Smaller blinds can be washed in a sink or tub; blinds can also be gently hose washed outdoors. Rinse off suds thoroughly. Drain the head rail and bottom rail; remove end caps if necessary. Towel dry to avoid water marks.

To have your blinds cleaned professionally, check the local telephone directory for a Venetian blind cleaning service or laundry.

Cloth tapes – spot clean with a fabric cleaner – test an inconspicuous area (such as the back or bottom of the blind) before proceeding

Polyester ladder tapes can be cleaned with distilled water and a clean cloth.

### **REPLACEMENT PARTS**

In the event that replacement parts are ever needed, you may call: 1-800-264-1190

Please be sure to provide the following information, if possible:

- The complete model or catalog number of your product
- A description of the product
- A description of the part needed

### **LIMITED LIFETIME WARRANTY**

The enclosed product is warranted to the original residential retail purchaser as long as the product remains in the original window.

#### **Covered:**

Lifetime: Entire product against manufacturing defects (i.e. a flaw in the product design, materials, or workmanship that causes the product to no longer function)

3 years: Cords including internal cords such as those found in cordless blinds. 5 years: All fabric

**Not Covered:**

Normal Wear and Tear

**Any product that fails due to:** abuse • exposure to salt air • improper installation • accident • extraordinary use • improper operation • alterations • improper cleaning • misapplication • damage from pests/insects/pets • improper handling • misuse

**Natural wood products that have:** loss of color intensity • yellowing or cracking of plastic parts or foam wood product • variations in color, grain, or texture

• warping of wood slats in high humidity areas

**Costs associated with:** product removal • transportation to and from the retailer • brand label removal • product remeasure • incidental or consequential damages • product reinstallation • shipping

In the event there are multiple blinds/shades in the same room, only the defective blind/shade will be replaced.

**To Report Shipping Damage:**

If damage occurred during shipping, call place of purchase and report within 7 calendar days or else you may be denied credit for your damaged product.

**To Obtain Service:**

If you suspect this Phase II product has a manufacturing defect in materials or workmanship:

1. Locate the sales receipt
2. Call place of purchase

Any unauthorized returns will not be accepted.

**Warranty Remedy:** THIS SHALL BE YOUR SOLE REMEDY UNDER THIS LIMITED WARRANTY.

If this product is found to have a manufacturing defect in materials or workmanship, we will (at our discretion) do one of the following: repair the product • replace the product • refund the cost of the product

Colors vary from lot to lot and may not exactly match sample swatch or previous purchases. Discontinued items or color selections will be replaced with the closest equivalent current product.

**YOUR RIGHTS UNDER STATE LAW:** This lifetime limited warranty gives you specific legal rights, and you may have other rights, which vary from state to state. Some states do not allow limitations on how long a warranty lasts, so the above limitations may not apply to you. No agent, representative, dealer, or unauthorized employee has the authority to increase or alter the obligation of this warranty. This lifetime limited warranty supersedes any previous versions.

PHASE II PRODUCTS, INC.

501 WEST BROADWAY, SUITE 1350 SAN DIEGO, CALIFORNIA 92101

